

USER MANUAL

SPARKULAR® BLASTER

V1.0

2024/05/28



Showven Technologies Co., Ltd.

Thanks for choosing SPARKULAR® BLASTER, we wish it will sparks up your show. Please read the following manual carefully before operating this product.

Δ Safety Instructions

- ⚠ Unauthorized repair are prohibited, it may cause serious incident.
- ⚠ SPARKULAR® BLASTER can't be used in rain, please keep the device dry.
- ⚠ Make sure lid of feeding hopper are well covered when use SPARKULAR® BLASTER. If the consumable in hopper is accidentally ignited, pour it out as soon as possible.
- ⚠ Consumable should keep away from moisture and stored in a dry sealed environment.
- ⚠ Check whether there is consumable aggregate in the output nozzle both before and after each show, if any, please clean it up, or it will affect the firing effect, damage machine, even cause serious incident.
- ⚠ There will be some sparks drop to ground, make sure there are no flammable objects such as carpet on the ground within the safety radius of the machine.
- ⚠ Please only use HC8200 MEDIUM originally from SHOWVEN®, otherwise it may cause jam even damage the machine.
- ⚠ Make sure that children, unauthorised people and animals do not obtain access to the SPARKULAR® BLASTER.
- ⚠ Only use the original 29.4V charger for charging. It is prohibited to use other chargers for charging, otherwise it may damage the machine.
- ⚠ Do not store the battery for a long time after being completely discharged (it is recommended to charge it once at least every two months) to prevent the battery from entering an over-discharge state, resulting in battery die out.
- ⚠ Cover the output air inlet and outlet of SPARKULAR® BLASTER is forbidden.
- ⚠ Never touch the nozzle of SPARKULAR® BLASTER danger of getting burnt.
- ⚠ Never touch the sparks which shooting out from the nozzle.

Safety Distance

- ⚠ Safety distance for SPARKULAR® BLASTER divided into two parts safety radius around machine is 1m and safety distance at firing direction is 5m. SPARKULAR® BLASTER with a suggested 0-60° manual waving firing angles. No person and flammable materials are allowed to stay inside the safety isolation zone (including all waving angle direction) when SPARKULAR® BLASTER was armed.
- ⚠ Due to SPARKULAR® BLASTER is a handheld wireless system, please Make sure there are no objects near the machine and within the output distance that can be damaged or catch fire by the emitted powder and sparks from it.
- ⚠ In windy environment, increase the safety distance according to the wind direction and speed.
- ⚠ Sparks and consumables from the machine can lead to serious eye injury. Always wear safety goggles when firing it or enter the safety zone.

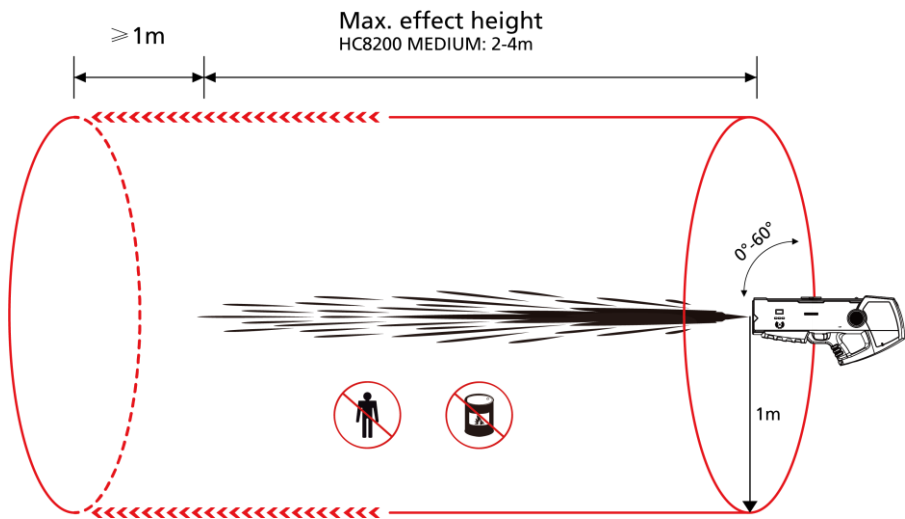

Δ Description

SPARKULAR® BLASTER is a brand new handheld SPARKULAR® machine. We break through the traditional SPARKULAR® design and creatively adopt a brand new structural concept makes SPARKULAR® BLASTER a fantastic handheld spark effects device for DJs, singers etc. applications on stage.

Δ Technical Specifications

- \ **DIMENSION:** 585×270×95mm
- \ **WEIGHT:** 3.1kg (exclude battery)
- \ **VOLTAGE:** AC100-240V, 50/60Hz
- \ **WORK POWER:** 140W
- \ **BATTERY:** 18650 * 14pcs (Not included in standard configuration)
- \ **HEATING UP TIME:** 2min
- \ **STANDBY TIME:** 90min (with PANASONIC NCR18650B)
- \ **CHARGING TIME:** 40min
- \ **HC8200 CONSUMPTION:** 17g/min
- \ **EFFECT HEIGHT ADJUSTBLE:** YES
- \ **FIRING ANGLE:** between 0°~ 60°
- \ **INTERFACE:** ARM and Trigger key
- \ **WORK TEMP.:** -10°C~50°C
- \ **CONSUMABLE AND EFFECT HEIGHT:** MEDIUM (2-4m)

Δ Structure of SPARKULAR® BLASTER

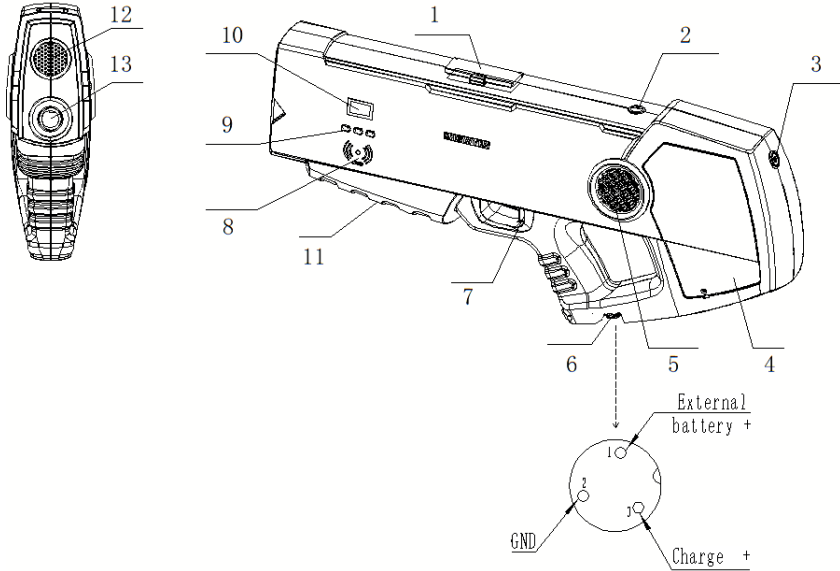

1. Feeding Hopper Lid
2. ARM Switch: switch to ON before firing, when the indicator light FLASH means machine is in process of heating up, ON means armed and ready to firing.
3. Power Switch
4. Battery Box Cover: install battery at both side
5. Air Inlet
6. Charging
7. Firing Trigger
8. RFID Card Reader
9. Keypad
10. LCD display
11. Type C port: for software update
12. Heat Dissipate Vent
13. Output Nozzle

Δ Operation Panel

1. Keypad area

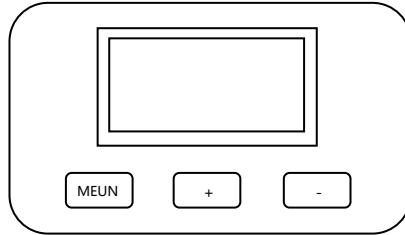

MENU: Press enter setting interface

UP: Parameter up

DOWN: Parameter down

2. RFID area

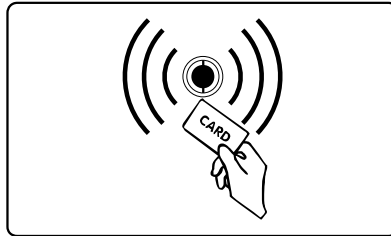

RFID card come with consumable HC8200 bags, swiping card to identify parameters and types of granules. The RFID card is disposable, one card can only use one time. Each card can increase single machine 20min working time, the maximum recharge time for SPARKULAR® BLASTER is 30min.

Δ Display Interface

1. Welcome interface

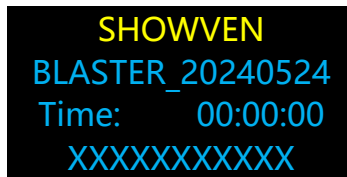

First Line: SHOWVEN

Second Line: MODEL and software version

Third Line: Accumulated heating up time

Fourth Line: Serial No.

2. Main Interface

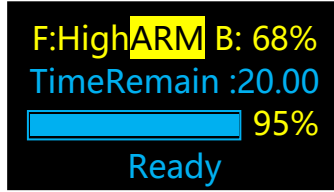

First Line: Output Level (High, Mid, Low); ARM status display, Battery Volume

Second Line: Time Remain

Third Line: Current Core Temp. and temp. progress bar

Fourth Line: BLASTER status and alert / error message

3. Alert / Error information

| Alert Message | Why it appears | How to remove |
|------------------|--|---|
| E0 System IC | Not original powder, machine will stop working | Contact SHOWVEN |
| E1 FAN Motor Un | Fan not well connected or circuit problem | Check the fan terminal connection, if can't solve please contact SHOWVEN. |
| E1 Fan Stall | Fan stuck | Restart BLASTER, if still not solve please check the fan and clean it. |
| E1 Shaft Stall | Shaft stuck | Restart BLASTER, if still not solve please contact SHOWVEN. |
| E2 Temp.Sensor | Temp. sensor terminal connector loose or sensor damage | Check connection or replace a new sensor |
| E3 PTemp.Over | PCB over temp. | Power OFF BLASTER and let it cool down |
| E4 TimeRemain | Time Remain less than 10min | Read a RFID card |
| E5 KTemp.Over | Heating coil over temp. | Power OFF BLASTER and let it cool down |
| E6 Heat Fail | Heating fail | Restart BLASTER, if still not solve the problem might be heating PCB or mainboard |
| E9 Battery Error | Battery voltage error | Charge first, if not solve then need to change battery |

4. Main Menu

Parameters in main menu show in below table, press "UP"/ "DOWN" to change the value.

| Options | Range | Default | Explanation |
|-----------------|------------------|---------|--|
| Density | 30%-100% | 100% | Density set |
| Set Temperature | 420-480 | 450 | Heating coil temp. setting |
| Standby Switch | ON/OFF | OFF | ON: Temp. need to achieve set temp. before BLASTER can be firing |
| Output | High / Mid / Low | High | Output set up |
| Manual Fan | ON/OFF | OFF | ON: fan will keep working at low speed even not firing. |

▲ Operation Guide

1. Battery installation

SPARKULAR® BLASTER can be powered through 14 pcs of 18650 cells. New SPARKULAR® BLASTER come only with battery compartment, customer need to get 18650 cells locally. The battery we suggest to use is with flat head as below:

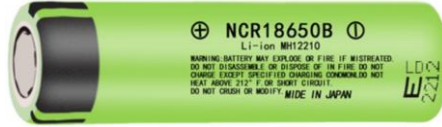

The battery installation steps:

- Unscrew the screw of the battery box at the both sides of SPARKULAR® BLASTER.
- Install the battery in correct direction, pay attention to the positive and negative pole. Wrong installation will damage the battery box or even machine.
- Install back the battery box cover.

NOTICE: To avoid the damage of battery, charge the battery at least once per month.

NOTICE: Installing the battery in wrong direction may cause the battery to heat up and damage the device. If any abnormality is found, remove the battery as soon as possible.

NOTICE: In case the battery level is abnormal, remove all batteries and measure the voltage of each battery. If the voltage is less than 3V, the battery is damaged, please replace a new one.

NOTICE: Only use an insulated plastic spudger to remove the battery. Metal spudger will cause short circuits and damage machine.

2. Charging

Power OFF SPARKULAR® BLASTER, use SHOWVEN original 29.4V charger to charge the machine. There is a indicator light on charger, RED means charging, GREEN means charging completed.

NOTICE: Only use the original 29.4V charger for charging. It is prohibited to use other chargers for charging, otherwise it may damage the machine.

NOTICE: In case operator need to keep heating up and firing BLASTER whenever they want for a long period of time. We can charge the SPARKULAR® BLASTER when it is powered on. But please keep the device in a good ventilation area for heat dissipate.

3. Fill SPARKULAR® BLASTER

- Open powder bags and fill the feeding hopper.
- Only HC8200 MEDIUM is suggest to use on SPARKULAR® BLASTER.
- Please be noted that there may sparks or remains fall to the ground. Make sure no flammable material on ground or in the region where going to use the SPARKULAR® BLASTER.
- Make sure the lid of hopper is locked tight after filling.
- Swipe an RFID card to activate BLASTER.

NOTICE: Accidentally burning of consumable HC8200 in the hopper please pouring it out as soon as possible and use sands to extinguish.

NOTICE: SPARKULAR® BLASTER report E4 when remaining time is less than 10 minutes.

4. Heating up and Firing

- a) Power ON machine, it will heat up automatically. It will show heating progress bar on the screen.
- b) Adjust the output, by setting it in the menu.
- c) Double confirm the prescribed safety isolation zone is clear, no person, animal or other property within this region.
- d) The operator should not fire towards people, animals, flammable objects or other objects which might be damaged by sparks.
- e) Switch ON the arm button
- f) Press and hold the firing trigger, have fun!

NOTICE: *The best output angle for SPARKULAR® BLASTER is between 0° to 60° upward.*

NOTICE: *Blower will keep working for few seconds after release the firing trigger.*

NOTICE: *Suggest to switch off the arm switch for SPARKULAR® BLASTER after firing, switch on again when needed.*

5. Turn Off and clean up

- a) Switch OFF the arm switch, power off SPARKULAR® BLASTER, allow SPARKULAR® BLASTER to cool down.
- b) Empty the remaining HC8200 in hopper, and store the remaining HC8200 in a dry sealed bottle for next time use. Never touch the output nozzle of SPARKULAR® BLASTER when empty the hopper. DANGER OF GET BURNT!
- c) Clean the machine and put it back to suitcase after it is fully cool down.

Δ Optional parts

1. External Battery Pack

External Battery Pack is an optional part to extend SPARKULAR® BLASTER standby time, it can double the standby time for SPARKULAR® BLASTER. Extremely suitable for touring or outdoor when charging is not accessible.

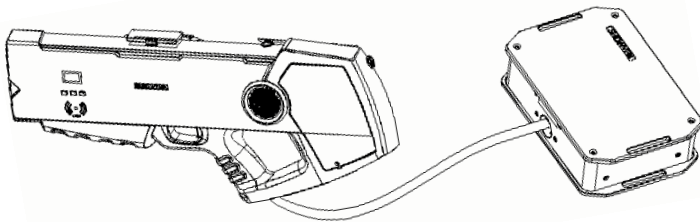

2. BLASTER Stand

Assemble the stand as shown below, raise one end of the “Y” holder to the highest position and the other “Y” holder end to the lowest position, so that the BLASTER is in a horizontal state when placed on it.



Δ Maintenance

- a) Empty the feeding hopper before shipment of machine.
- b) Empty the feeding hopper if long time not use, for high humidity environment we suggest to empty feeding hopper after each show.
- c) Firing the machine few seconds after empty the feeding hopper to clear remaining material which may exist inside machine after each show.

Δ **Warranty Instructions**

- \ Sincere thanks for your choosing our products, you will receive quality service from us
- \ The product warranty period is one year. If there are any quality problems within 7 days after shipping out from our factory, we can exchange a brand new same model machine for you
- \ We will offer free of charge maintenance service for machines which with hardware malfunction (except for the instrument damage caused by human factors) in warranty period. Please don't repair machine without factory permission

Below situations NOT included in warranty service:

- \ Damage caused by use other type of consumable which is not originally from SHOWVEN®.
- \ Damage caused by improper transportation, usage, management, and maintenance, or damage caused by human factors;
- \ Disassemble, modify or repair products without permission;
- \ Damage caused by external reasons (lightning strike, power supply etc.)
- \ Damage caused by improper installation or use;

For product damage not included in warranty range, we can provide paid service.

Invoice is necessary when applying for maintenance service from SHOWVEN®.

SHOWVEN[®]



Showven Technologies Co., Ltd.

Tel: +86-731-83833068

Web: www.showven.cn E-mail: info@showven.cn

Add: No.1 Tengda Road, Liuyang Economic & Technical Development Zone, Changsha, Hunan,
410300, P.R.China