

USER MANUAL

SPARKULAR® FALL

V2.2

2024/06/24



Showven Technologies Co., Ltd.

Thanks for choosing SPARKULAR® FALL, we wish it will sparks up your show. Please read the following manual carefully before operating this product.

Δ **Safety Instructions**

- ⚠ Unauthorized repair are prohibited, it may cause serious incident.
- ⚠ Keep SPARKULAR® FALL dry and do NOT use in rain or snow.
- ⚠ Make sure lid of feeding hopper are well covered when use SPARKULAR® FALL.
- ⚠ Accidentally burning of consumable can only use sands to extinguish.
- ⚠ Consumable should keep away from moisture and stored in a dry sealed environment.
- ⚠ Check whether there is consumable aggregate in the output nozzle both before and after each show, if any, please clean it up, or it will affect the firing effect, damage machine, even cause serious incident.
- ⚠ The SPARKULAR® FALL power supply cable maximum allowed cascade of 6pcs (BT04) / 3pcs (BT05), exceed connecting may result in damage or even cause fire.
- ⚠ For better heat dissipation, block the air intake and air outlet is prohibited.
- ⚠ Cover the output nozzle of SPARKULAR® FALL is forbidden, inspect the machine before each show, making sure no objects or material will block the output nozzle.
- ⚠ Never touch the nozzle of SPARKULAR® FALL, danger of getting burnt.
- ⚠ Never touch the sparks which shooting out from the nozzle.
- ⚠ Make sure no staff, audience and flammable materials stays under the SPARKULAR® FALL.

Safety Distance

- ⚠ Keep audience and flammable material at a minimum distance of 3m from SPARKULAR® FALL.
- ⚠ Make sure sparks shoot out from SPARKULAR® FALL can NOT touch any objects. And keep a clearance with minimum 2m from the setting maximum effect length.
- ⚠ Human, animal or flammable materials are not allowed to close to the underside area where hanging SPARKULAR® FALL.
- ⚠ In windy environment, increase the safety distance according to the wind direction and speed.
- ⚠ The safety zone area shifts accordingly when machine installed in tilt position. Please increase the safety distance in the direction which machine tilt.
- ⚠ Sparks and consumables from the machine can lead to serious eye injury. Always wear safety goggles when enter the safety zone.

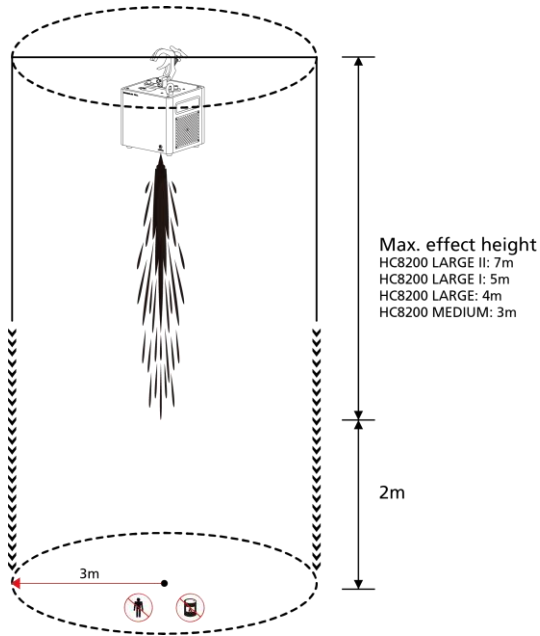

Δ Description

SPARKULAR® FALL is hanging special effects equipment for indoor/outdoor use to generate dazzling silver “waterfall” sparks effects. According to different usage scenarios, operator can self define various types of “spark curtain” effects vary from 2m to 7m by use of different types of HC8200.

Δ Structure of SPARKULAR® FALL

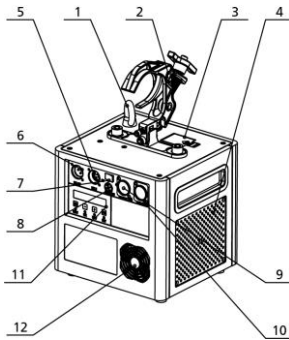

- 1. Safety Loop
- 2. Clamp
- 3. Feeding Hopper Lid

4. Air Intake
5. DMX IN
6. DMX OUT
7. Power Switch
8. Fuse
9. Power IN
10. Power OUT
11. LCD Screen
12. Cooling Fan

Schematic diagram of the top fixing hole

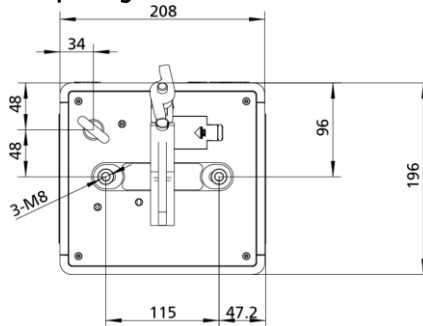

Δ Technical Specifications

- ∨ **MODEL:** BT04/BT05
- ∨ **DIMENSION:** 196×208×192mm
- ∨ **WEIGHT:** 6.0kg
- ∨ **VOLTAGE:** 220V(BT04)/110V(BT05), 50/60Hz
- ∨ **WORK POWER:** 500W
- ∨ **EFFECT HEIGHT:** 2-7m(according to HC8200 type)
- ∨ **INTERFACE:** 3-pin XLR, POWER IN/OUT
- ∨ **CONTROL:** DMX 2 channels, Wireless Remote
- ∨ **ADAPTABLE TRUSS SIZE:** 40-60mm

Δ Operation Panel

1. LED display area:



- READY:** Flash means machine is preparing, LED keeps on means ready to work
- DMX:** Flash means DMX signal is connected, light OFF means there is no DMX signal
- FAULT:** Light ON when error occurs
- HEAT:** Light ON when system is heating up

2. Control button area:

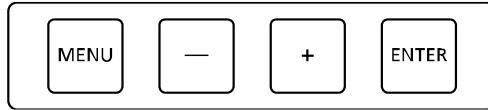

MENU: Press to switch through menu, press and hold for 3s enter advanced menu

-: Parameters down

+: Parameters up

ENTER: Confirm and save parameters.

3. Bottom Indication Light



Off: Preheating not activated or machine is firing

Quick Flashing: Preheating

Long on: Preheated

Slow Flashing: Error warning

The indication light can be turned off in menu.

4. RFID area

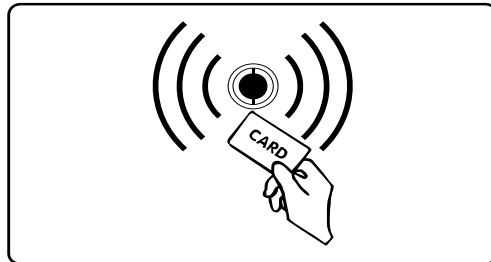

Composite Ti with RFID card, swiping cards used to identify parameters and types of granules. The RFID card is disposable, one card can only use one time.

Δ Interface

1. Main Interface



First line: Display DMX address is "1"

Second line: Display the present inner core temperature and the temperature progress bar; displays remaining time is 7 minutes and 24 seconds.

2. Error information

Error information	Explanation
E0 System IC	Systematic error
E2 Temp. Sensor	Temperature sensor is not connected or damage
E3 P Temp. Over	Chassis over-temperature
E4 Time Remain	Insufficient granules or remaining time, please swiping time card
E5 K Temp. Over	Heating chamber over-temperature
E6 Heat Fail	Heating failed

3. Setting Menu

Press "MENU" to enter the Setting interface, press the "MENU" button to enter different options until you return to the main interface

Options	Range	Default	Explanation
Set DMX Address	1-512	1	Set the DMX address, machine become a wireless host and can send out DMX signal when its address is "1++"
Wireless Control	ON/OFF	OFF	Wireless function switch, you can match machine with remote controller when at "ON" status
Manual Fountain	ON/OFF	OFF	Manual fountain switch, for testing purposes only
Fountain Height	1 / 6	1	1 is low level, 6 is high level

4. Advanced Menu

Press and hold "MENU" for 3s to enter the advanced setup interface, press MENU key to enter different options, wait 3 seconds to return to the main interface

Options	Range	Default	Explanation
Set Temperature	480-620	580	Setup inner Core temperature
Auto Heat	ON/OFF	OFF	Auto preheat function switch after turn on machine
Density	70-100	90	Adjust the sparks density
Mode Selection	Factory Mode User Mode	User Mode	Factory Mode is factory debugging mode, User Mode is using mode
DMX Channel Mode	2 / 4 / 2+3 DMX Channel	2 DMX Channel	Don't change. 4 DMX Channel and 2+3 DMX Channel are for special use.
Tip Over Error	ON/OFF	OFF	Tip over sensor ON/OFF
Default Parameter			Useless
Standby Switch	ON/OFF	OFF	When ON, the machine can firing only when heating up was finished
Status LED	ON/OFF	ON	Bottom indicate light ON/OFF

5. DMX mode

When using the DMX controller, SPARKULAR® FALL occupy 2 DMX channel

The First channel	Functions
0-15	Firing OFF
16-135	Low Level Fountain ON
136-255	High Level Fountain ON
The second channel	Functions
60-80	Clear Material
20-40	Emergency Stop
0-10	Pre-heat OFF (Disable in Auto-heat)
240-255	Pre-heat ON (Disable in Auto-heat)

Δ Operation Guide

1. Check output nozzle of SPARKULAR® FALL

Check carefully the output nozzle of each machine, make sure the output nozzle is in good shape and there is no powder aggregate.

2. Fill SPARKULAR® FALL

- Open powder bags and fill the feeding hopper. Hopper capacity of SPARKULAR® FALL is 280g.
- Choose correct consumable according to the hanging height and safety distance.
- Make sure the lid of hopper is locked tight after filling.

HC8200	Fall length (Low Level)	Fall length (High Level)
MEDIUM	2m	3m
LARGE	3m	4m
LARGE- I	4m	5m
LARGE- II	5m	7m

3. Install SPARKULAR® FALL

- Vertical hanging installation is preferred for SPARKULAR® FALL. If need to installed SPARKULAR® FALL in angles, please turn the Tip over to OFF status first, maximum firing angle is 45 ° and can only be angled to the front side of the machine as below picture.
- Make sure the machine is securely hanging on truss to avoid falling. An extra safety rope is required for extra safety.

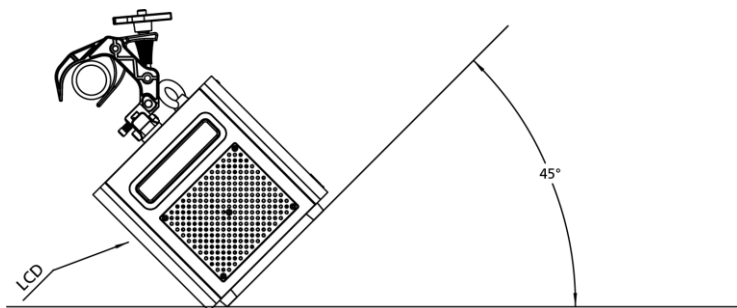

4. Connect Power / DMX cable

- a) Connect a power cable to the POWER IN socket of SPARKULAR® FALL. Connect the other end of power cable to the power source. Make sure power supply is consistent with the rated voltage of the equipment, and the socket must be well grounded.
- b) If connect machine in sequence, please connect a power link cable to the POWER OUT of previous machine, connect the other end of the power link cable to POWER IN of the next machine.
- c) The SPARKULAR® FALL power supply cable maximum allowed cascade of 6pcs (BT04) / 3pcs (BT05). Do not connect exceed units to a single electrical circuit.
- d) Power ON all SPARKULAR® FALL.

e) Assign DMX address for each unit of SPARKULAR® FALL. If use SHOWVEN host controller or FXcommander to control the machine please allocate a unique DMX address for each unit of machine.

If use remote controller to control SPARKULAR® FALL wirelessly, please set machine to wireless ON status and match machine with remote controller. For DMX cable control please execute below operations (f to h).

- f) Connect a DMX cable to the DMX IN socket of first unit of SPARKULAR® FALL, connect the male connector end of DMX cable to your DMX controller (FXcommander, HOST CONTROLLER, light console etc).
- g) Connect a DMX cable to the DMX OUT of previous machine, and the other end of to the DMX IN of next machine. Connect all devices in series in this way.
- h) Suggest to plug in a DMX terminator into the DMX OUT in last unit of machine to improve signal reliability. Signal amplifier is required for long distance (>200m) DMX signal transmission.

5. Activate SPARKULAR® FALL by swipe RFID card

- a) Swipe an RFID card. Read the card as show below. SPARKULAR® FALL shows time remain if read successfully.
- b) SPARKULAR® FALL will report E4 when remaining time is less than 10 minutes.
- c) Please note each RFID card come with 200g package HC8200 can increase single machine 20min working time, the maximum recharge time for SPARKULAR® FALL is 30min, when time remain reached 30min, it can't recharge anymore RFID card.

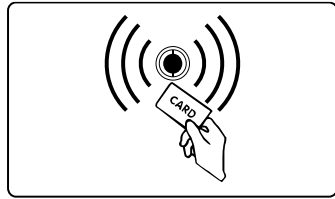
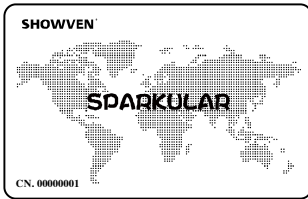

6. Programming and Firing

- a) Programming SPARKULAR[®] FALL, set the firing height, firing sequences etc.
- b) Heating up machine, it takes around 5min. it varies according to the voltage and environment temperature.
- c) Make sure the prescribed safety zone is clear.
- d) Suggest to clear material before firing.
- e) Firing. In order to prevent overheat in the heating chamber and protect machine, the maximum continuous firing time for SPARKULAR[®] FALL is 30s.
- f) The operator should always have a clear view of the device, so that he/she can stop the show immediately when there is danger.
- g) Clear material for SPARKULAR[®] FALL for 5s after show, clear material will remove the remaining particles from heating chamber. For angled installation please elongate clear material time.

7. Turn off and Clean up

- a) Power off SPARKULAR[®] FALL, allow SPARKULAR[®] FALL to cool down.
- b) Disconnect all POWER and DMX cables. Remove the machine from truss carefully.
- c) Empty the remaining HC8200 in hopper, and store the remaining HC8200 in a dry sealed bottle for next time use. Never touch the output nozzle of SPARKULAR[®] FALL when empty the hopper. DANGER OF GET BURNT!
- d) Clean the surroundings to remove powder residues.

Δ Wireless Control Information

1. Wireless remote control mode:

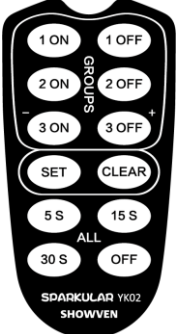

When use wireless remote control, please unplug DMX cable connection on machine, set Wireless Control at ON status, match the remote controller with machine, pull out the antenna on remote controller.

1 ON	DMX address "1" ON	1 OFF	DMX address "1" OFF	
2 ON	DMX address "3" ON	2 OFF	DMX address "3" OFF	
3 ON	DMX address "5" ON	3 OFF	DMX address "5" OFF	
SET	Match the machine with remote	CLEAR	Clean material for 3 seconds	
5 S	All firing 5s	15 S	All firing 15s	
30 S	All firing 30s	OFF	All stop	

NOTE:

- When the indicator light becomes weak on the remote controller, please replace the battery.
- When the machine is occasionally not working, may be caused by interference, please press the start button again.
- Wireless control is easily influenced by interference, suggests to stay as close to machine as possible when use remote controller, and machines cannot use metal shielding

3. Wireless host SPARKULAR® FALL mode (requires communication cables)

- In occasion of strong interference, using the wireless host can avoid interference, ensure stable control.
- Set the first unit of SPARKULAR® FALL DMX address into "1++", this machine address is "1", but it can also output DMX signal and turns into wireless host SPARKULAR® FALL.
- Use communication cables to connect all SPARKULAR® FALL, the host SPARKULAR® FALL will receive the signal from remote controller and transfer to all other SPARKULAR® FALL via communication cable to realize stable signal transmission.

Δ Maintenance

- Empty the feeding hopper before shipment of machine.
- Empty the feeding hopper if long time not use, for high humidity environment we suggest to empty feeding hopper after show.
- Clear material both before and after the show.
- Recommended to wash or replace the air intake filter every two months.

Δ **Warranty Instructions**

- \ Sincere thanks for your choosing our products, you will receive quality service from us
- \ The product warranty period is one year. If there are any quality problems within 7 days after shipping out from our factory, we can exchange a brand new same model machine for you
- \ We will offer free of charge maintenance service for machines which with hardware malfunction (except for the instrument damage caused by human factors) in warranty period. Please don't repair machine without factory permission

Below situations NOT included in warranty service:

- \ Damage caused by use other type of consumable which is not originally from SHOWVEN®.
- \ Damage caused by improper transportation, usage, management, and maintenance, or damage caused by human factors;
- \ Disassemble, modify or repair products without permission;
- \ Damage caused by external reasons (lightning strike, power supply etc.)
- \ Damage caused by improper installation or use;

For product damage not included in warranty range, we can provide paid service.
Invoice is necessary when applying for maintenance service from SHOWVEN®.

SHOWVEN[®]



Showven Technologies Co., Ltd.

Tel: +86-731-83833068

Web: www.showven.cn E-mail: info@showven.cn

Add: No.1 Tengda Road, Liuyang Economic & Technical Development Zone, Changsha, Hunan,
410300, P.R.China