

USER MANUAL

uFlamer II

V1.2
2024/11/12

SHOWVEN®



SHOWVEN Technologies Co., Ltd

Thanks for choosing SHOWVEN uFlamer II, we wish it will bring you lots of exciting moments. Please read the following user's manual and related product installation guide carefully before operating this device.

△ Safety Instructions

1. Safety icons explanation

Safety instructions warn of hazards when handling equipment and provide information on how to avoid those hazards. They are classified according to the severity of the hazard and are divided into the following groups. Please do follow all safety instructions in this document!

DANGER: Indicates a hazardous situation that, if not avoided, will result in death or serious injury. (This signal word is limited to the most extreme situations)

WARNING: Indicates a hazardous situation that, if not avoided, could result in serious injury

CAUTION: Indicates a hazardous situation that, if not avoided, could result in minor or moderate injury.

NOTICE: Provide additional or supplementary information.

2. General Safety Instructions

- ∨ Unauthorized repair are prohibited, it may cause serious incident.
- ∨ Make sure power supply is consistent with the rated voltage of the equipment, and the socket must be well grounded. Unplug and turn off the machine when not in use.
- ∨ Please connect DMX cable before power on uFlamer II, and ensure that the communication command is disabled, and the safety switch of the device is under test mode.
- ∨ After turning on the device, no person is allowed to stay in the danger area. Ensure all persons that are part of the show are informed about the safety distance, risks and functions of the device.
- ∨ Always have a CO₂ fire extinguisher and an extinguishing blanket in case of need.
- ∨ If there is any doubt as to the safety operation of the device in any circumstances, the device should be taken out of service immediately. Be sure the device is in good operating condition before use. If it fails to fire correctly, immediately shut down and check it accordingly. Any questions please always contact SHOWVEN (info@showven.cn) for help.
- ∨ Be sure to use high quality fuels, otherwise, it easily leads to failure or danger. Please keep fuels away from heat source, sparks, fire or other possibility of ignition. Do not smoke!
- ∨ The operator responsible for the control of the flame system must always have a clear view of the device, so that he/she can stop the show immediately when there is danger. The main AC power switch should be near the operator. So that the operator can turn off the power of all devices in case of abnormal.
- ∨ The device shall not be altered and applied to other use purposes.

3. Disclaimers:

SHOWVEN technologies Co., Ltd excludes liability for unsafe situations, accidents and damages resulting from:

1. Ignoring warnings or regulations as shown on product manual or this manual.
2. Use for other applications or circumstances other than those indicated herein.
3. Changes to the device, including use of non-original spare parts, lack of maintenance etc.
4. Dismantling device without authorization from SHOWVEN.
5. Use of this machine by unqualified or untrained personnel.
6. Improper use of machine.

Warning:

A dry powder fire extinguisher, a carbon dioxide fire extinguisher and a fire blanket must be equipped next to the equipment. Someone must be on duty during operation. In case of fire accident, dry powder fire extinguisher can be used when the fire is large, and a carbon dioxide fire extinguisher can be used when the fire is small.

▲ Technical Specifications

- \\ **Model:** uFlamer II
- \\ **Housing Material:** Die-casting Aluminum
- \\ **Dimension:** 460×330×330mm
- \\ **Weight:** 25kg
- \\ **Input:** AC100-240V, 50/60Hz
- \\ **Work Power:** 500W
- \\ **Battery Powered:** Yes, 16pcs 18650 cells, 24h standby
- \\ **Ignition:** Dual, high voltage electron ignition
- \\ **Flame Monitoring:** Yes
- \\ **Dual Valve:** Yes
- \\ **Control:** DMX , 9-60V pyro signal, Wireless with Wireless DMX Receiver (5-PIN DMX IN with DC5V power supply)
- \\ **DMX:** 3-pin and 5-pin DMX IN / OUT
- \\ **E-Stop Interface:** Yes, can be connected in series
- \\ **Effect Direction:** Vertical
- \\ **Flame Height:** up to 12m
- \\ **Nozzle Optional (Max. height):** NOZZLE EL(6m), L (8m), PM (10m), H(12m)
- \\ **Tank Capacity:** 8L
- \\ **Fuel:** ISOPAR L, ISOPROPANOL
- \\ **Liquid Level Sensor:** Yes
- \\ **Fuel Tube Filter:** Yes
- \\ **Tip sensor:** Yes
- \\ **Usage in Rain:** Yes
- \\ **ARM light:** Yes
- \\ **Stereo Stand Hole:** Yes, (φ36mm, depth 62mm)

▲ Rear Panel

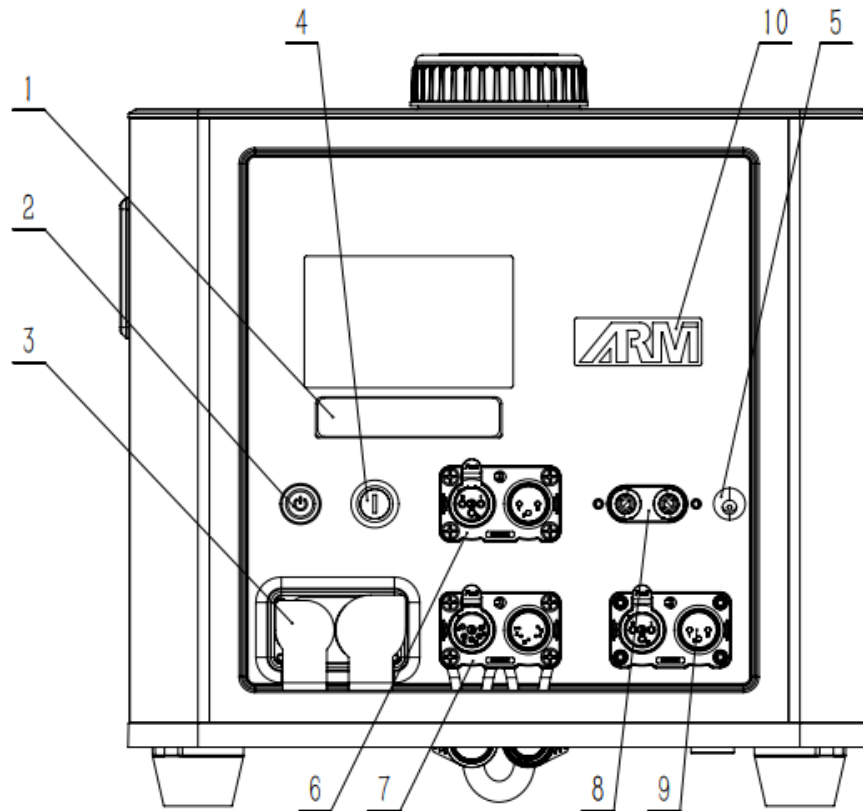

1. Touch button
2. Power Switch (with Power indicator light)
3. Power IN / OUT
4. Safety switch
5. DC12V external fuel pump power supply
6. 3-pin XLR IN/OUT
7. 5-pin XLR IN/OUT (5-PIN XLR IN can charge for wireless DMX pen through pin1 and 4, pin4 with DC5V power supply)
8. 9-60V pyro signal port
9. E-stop interface
10. ARM indicator light

▲ Display and setting





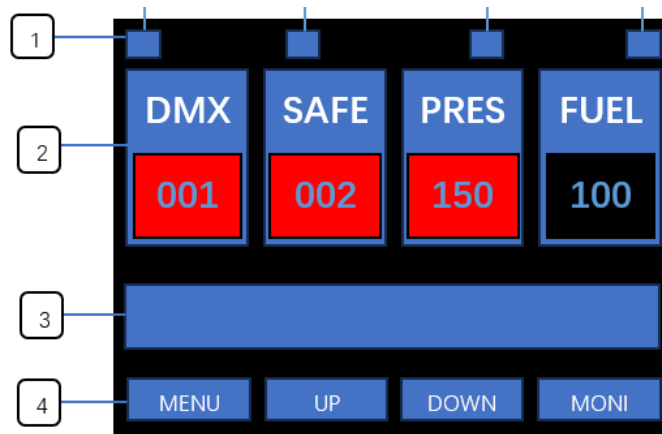

1. Welcome interface

Software Version	UFlamer II-240307
Serial Number	*****
Pump Run Time	00:00:00
Ignition Times	xx

2. Main interface



1.) Status Bar

-  : appears when "Flame Monitor" is "ON"
-  : appears when "Flame Monitor" is "ON" and detected successful ignition
-  : appears when "External Trigger" is "ON"
-  : appears when "safety switch" stay at "USER MODE"
- 2N/2P/6N** : DMX mode
-  : it appears when machine is charging
-  : battery volume
-  : No battery or battery box not connected

2.) Data Bar

DMX: DMX address, Background turns from BLACK to RED when DMX cable was connected.

SAFE: Safety address, Background turns from BLACK to RED when DMX cable was connected and safety channel activated.

PRES: Pressure value. Background turns from BLACK to RED when pressure reached / exceed 90% of "set pressure" value.

FUEL: Fuel level indicate. Background turns from BLACK to RED when actual fuel level (display in MONI) \geq "Fuel Level Alarm" setting in ADVANCED MENU.

3.) Message Bar

USER MODE / error or alert information display, Background color turns to RED when under "USER MODE".

4.) Touch Button function display:

First Button: MENU / BACK

Second Button: UP / LEFT

Third Button: DOWN / RIGHT

Fourth Button: MONI / EDIT / SAVE

3. ARM indicator light



Operators can enable/disable the arm indicator light by set the "ARM STATE" in ADVANCED menu. If "ARM STATE" is ON, there will be three status:

OFF: DMX signal input

BLINK: DMX armed or Ext Ignite in advanced menu is ON

ON: no DMX signal and Ext Ignite in advanced menu is OFF

4. Alert Message

Alert Message	Why it appears	How to remove
E0 Test Mode	Safety Key Switch at TEST MODE	Switch Key to USER MODE
E0 Factory Mode	Factory mode	Switch to Normal mode
E0 ExtIgnite ON	"External Trigger" is "ON"	Set "External Trigger" to "OFF" in Advanced menu
E0 Ignition Disenable	"Ignition" is "Disenable"	Set "Ignition" to "Enable" in Factory menu
E0 Key Lock	Touch button no operation in 30s	Restart machine

5. Error Message

Error Message	Why it appears	How to remove
E1 Pressure Err	Consecutive pressurize failure times exceed "Pressure Fail Cnt" setting value in factory menu	Restart machine or reset safety channel
E2 P Relief Err	Pressure high after depressurize	Restart machine
E3 Press Sensor	Pressure sensor disconnect / damage	please check pressure sensor.
E4 Pump Protect	Pump overload working	Power off machine and let the system cool down, then restart.
E5 Bat Err	Battery voltage abnormal	Charge for the battery. if still appear E5, battery might be damage please replace battery
E6 Tip Err	Machine slant over 45° , it stops running	Tip setting set to OFF, or horizontal install machine.
E7 Fuel Low	Actual "Fuel Level" < set value of "Fuel Level Alarm" in ADVANCED MENU	Fill the tank
E8 MissFire Exceed	Consecutive ignition failures exceed the set value of "Fl Moni Fail Num" in advanced interface	Restart machine / reset safety channel / set "Flame Monitor" to OFF

6. Monitoring Interface

Press "MONI" enter below interface

Menu	Explanation
Pressure	Current pressure value
Fuel Level	Current fuel level
Igniter Voltage	Flame monitoring value display
DC voltage	DC power supply voltage
BAT voltage	Battery voltage display
Pump A	Pump A current value
Pump B	Pump B current value
User Mode	<15000 is under test mode
Pump Run Time	Accumulative pump working time
Ignition Times	Accumulative ignition times

7. Menu Interface

Press "MENU" enter below interface

Menu	Explanation
MAIN	Main menu
ADVANCED	Advanced menu
TEST	Test menu
FACTORY	Factory menu (factory use only)

8. Main menu

Select "MAIN" in menu interface, press "EDIT" enter main menu. Use UP / DOWN / SAVE to change the parameters.

Menu	Range	Default	Explanation
Set DMX Address	1~512	1	DMX address setup
DMX Mode Select	2CH-N/2CH-P/6CH-N	2CH-P	DMX mode setup
Set Safety Address	1-512	2	Safety address setting under 2CH-P mode
Safety Level	76-120/ 102-153/ 127-178/ 153-204/ 178-229	102-153	Available only under 2CH-P mode. Safety channel DMX value within the set threshold range, firing enabled; outside the range, firing disabled.

9. Advanced menu

Select "ADVANCED" in menu interface, press "EDIT" enter advanced menu. Use UP / DOWN / SAVE to change the parameters.

Items	Contents	Default	Description
External Trigger	OFF / ON	OFF	Trigger through 9-60V pyro ignition signal
External Time	JOG, 0.1s~10.0s	0.2s	Firing duration under external trigger, this menu appears only when Ext Ignite is ON. If choose JOG, the fire duration will in accordance with the signal input, signal in firing start, signal stop firing stop. Max firing duration will be limited by "Max Jet Time"
Tip Setting	OFF / ON	ON	Turn ON/OFF tip over function
Fuel Alarm Switch	OFF / ON	ON	Turn ON/OFF low level alarm function
Fuel Level Alarm	0-100	5	Machine will alarm and stop working when fuel level lower than setting value
Fuel Input	ON / OFF	OFF	Automatic filling tank when fuel level low
PV ON FuelLevel	0-100	20	Automatic filling start when fuel level lower than this setting value. (Fuel Input ON status)
PV OFF FuelLevel	0-100	50	Automatic filling stop when fuel level exceed this setting value. (Fuel Input ON status)
Flame Monitor	ON/OFF	OFF	Flame monitor function ON/OFF setting
Flame Moni Value	0.01V-3.30V	0.4V	Threshold value for a successful firing
Fl Moni Fai Num	1-10	2	Consecutive ignition failures setting, if ignition fail times > setting value, machine will report error.
Key Sound	ON/OFF	ON	Touch button sound ON / OFF
ARM State	ON/OFF	ON	ARM indicator light ON/OFF setting
LCD Backlight	ON/OFF	OFF	LCD backlight ON/OFF. When ON, screen will flash when firing; OFF: LCD screen will turn off when no operation.
Key Lock	ON/OFF	OFF	ON: Touch button will disable if there is no operation in 30s. restart machine to active touch button.
Default Parameter	ON/OFF	OFF	Reset default parameter settings

10. Test menu

Please disconnect DMX connection before enter test menu.

Select "TEST" in menu interface, press "EDIT" enter test menu. Use UP / DOWN / SAVE to change the parameters.

"External Trigger" will disable after enter TEST menu, Pressure relief valve will open, below related items will shows Running when testing, shows Finish after test finished.

Items	Description
ARM Test	Test ARM indicator light, blink once/s, blink 3 times
Jet Valve 1 Test	Jet valve 1 ON/OFF 3 times, 1s per time
Jet Valve 2 Test	Jet valve 2 ON/OFF 3 times, 1s per time
Relief Test	Relief valve ON/OFF 3 times, 1s per time
Fuel Valve Test	Fuel Valve ON/OFF 3 times, 1s per time
Igniter 1 Test	Igniter 1 ON/OFF 3 times, 1s per time
Igniter 2 Test	Igniter 2 ON/OFF 3 times, 1s per time
Pump Test	Pump will pressurize to "Set Pressure" value and keep 2s, and display "F". If pressurize time exceed setting value of "Max Pressure Limit", means pump test fail, it will display "E". Display "R" means machine is pressurizing.

▲ DMX CONTROL

uFlamer II with 3 different channel mode: 2CH-P, 2CH-N and 6CH.

2CH-P:

In this channel mode uFlamer II occupies 1 functional channel CH-F and 1 separate safety channel CH-S (this channel is independent from operational channel, can be shared with other machine).

Channel	Function	Value
CH-F	Firing	0~110: Firing OFF 111~255: Firing ON
CH-S	Device enable / disable	0~101 and 154~255: Depressurize mode, disable device (Emergency STOP) 102~153: Pressurize mode, enable device Above setting is take the default safety level (102-153) setting as an example, other safety level value setting please refer to main menu

2CH-N:

In this channel mode uFlamer II occupies 2 functional channels.

Channel	Function	Value
CH-1	Firing	0~110: Firing OFF 111~255: Firing ON
CH-2	Firing Enable / Disable	0~239: Firing Disable (Emergency STOP) 240~255: Firing Enable

6CH:

In this channel mode uFlamer II occupies 6 functional channel. This channel mode is designed to control the uFlamer together with CIRCLE FLAMER on our Host Controller.

Channel	Function	Value
CH1	-	-
CH2	-	-
CH3	Firing ON/OFF	0~253: Firing OFF 254~255: Firing ON

CH4	Firing Duration setup	0 and 255: permanent fire (10s is limit duration time) 1~254: 10~2540ms duration time (Manual firing duration = DMX Value * 10ms)
CH5	-	-
CH6	Firing Enable / Disable	0~49 and 201~255: Firing Disable (Emergency STOP) 50~200: Firing Enable

▲ Operation

1. Safety distance explanation

Safety distance for uFlamer II divided into two parts safety radius around machine (a) and safety distance at firing direction (b). No person and flammable materials are allowed to stay inside the safety isolation zone when flamer was armed.

The safety radius around machine depends on the firing height (nozzle size).

For safety distance at firing direction equals to maximum firing height * 1.5.

Nozzle Type	Max. Flame Height	Safety Radius (a)	Safety Distance at Firing Direction (b)
SFSMA027 Nozzle EL	6m	2m	9m
SFSMA024 Nozzle L	8m	2.5m	12m
SFSMA028 Nozzle PM	10m	3m	15m
SFSMA026 Nozzle H	12m	3.5m	18m

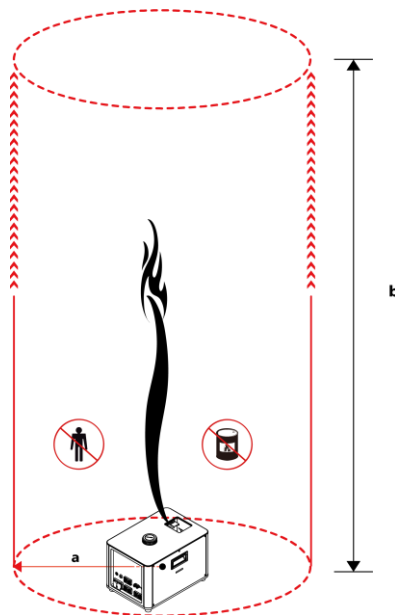

The uFlamer II safety isolation zone (show as below) is a cylindrical three-dimensional space with Safety radius around machine (a) and Height of b. Unauthorized persons and objects are strictly prohibited from entering.

For angled installation, the safety distance both around machine and firing direction should shift accordingly.

Safety distance in windy environment

The safety isolation zone radius (a) increase with wind direction and wind speed (v, m/s). The safety distance in windy conditions can be calculated as below:

For Nozzle L: $a = 2.5 + v$;

For example when the wind speed is 3m/s, we use the Nozzle L, then the safety isolation zone radius should be 5.5m.

CAUTION:

When the wind speed $\geq 8\text{m/s}$ (wind force ≥ 5), please use it with caution. When wind speed $\geq 17\text{m/s}$ (wind force ≥ 8), please stop use flamer.

2. Battery for uFlamer II

uFlamer II can be powered through 16 pcs of 18650 cells. New uFlamer II come only with battery compartment, customer need to get 18650 cells locally. The battery we suggest to use is with flat head as below:



The battery installation steps:

a) Unscrew the screws of the battery box at the bottom panel as below.

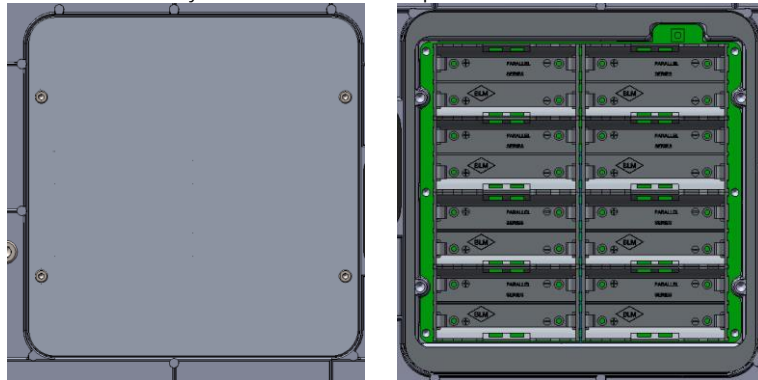

b) Install the battery in correct direction, pay attention to the positive and negative pole. Wrong installation will damage the battery box or even machine.

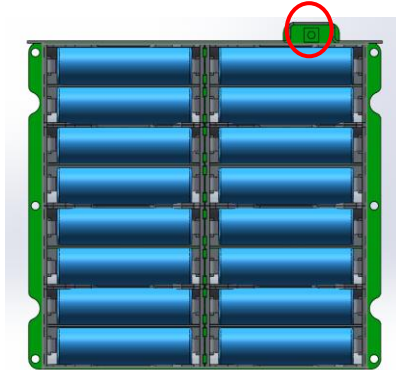

c) Press and hold the reset button (as show in the red circle below) for 1s to activate battery.

d) Install back the battery box plate.

e) Charging: charging automatically when machine connected with AC power supply (no matter machine was powered on or not)

NOTICE: To avoid the damage of battery, charge the battery at least once per month.

NOTICE: 18650 battery activation is necessary whenever install the battery

3. Install uFlamer II

a) Choose the correct nozzle, ensure the installation position of uFlamer II meet above safe distance requirements. New uFlamer II supplied with a nozzle PM which generate up to 10m flame.

b) Horizontal installation is preferred for uFlamer II. If need to install uFlamer in angles, to avoid fake error message please turn the TIP Setting and Low fuel switch to OFF status first. uFlamer with maximum tilt angle of 45° or -45° , and it can be angled to two directions as show in below picture. Besides please be aware the fuel level in fuel tank to avoid fuel leakage when tilt installation.

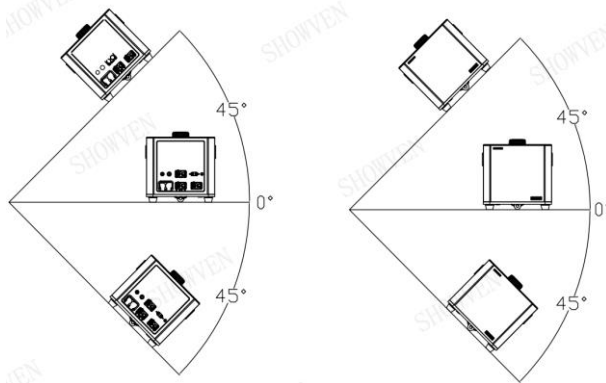

- c) For truss installations always connect with safety rope to ensure extra safety. If there is any other national or regional guidelines please follow it accordingly.
- d) Double confirm the machine was firmly installed.

4. Fuel the uFlamer II

- a) Switch safety lock to TEST MODE.
- b) Fill the fuel tank with qualified fuel. To prevent the fuel from overflowing the tank please not exceed the upper limit (top of the yellow sponge).

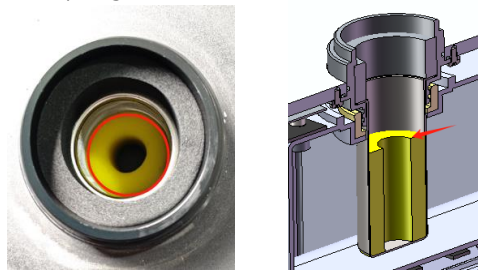

WARNING: Fuel requirements for uFlamer II

1. Water content in fuel should less than 0.5%
 2. For maximum safety, please use fuel with flash point between 60-80°C, ISOPAR L or M is highly recommended.
 3. Colored fuels are forbidden to use on uFlamer II it may damage the machine.
- SHOWVEN excludes liability for the losses, damages and accidents caused by not using qualified fuels in accordance with this requirement.

5. E-Stopper / E-stop terminator Connection

E-stop interface is a power cut-off interface, the machine can be powered on normally only when E-STOP in is connected. For safer use of uFlamer II we suggest to connect it with E-stopper. For operators who don't want to use E-stopper can plug a E-stop terminator in E-STOP IN to enable the device.

E-Stopper (optional) connect with single unit of uFlamer II.



E-Stopper (optional) connect with multi units of uFlamer II in daisy chain.



NOTICE: A unit of E-Stopper can control maximum 24 units of device.

Use E-stop terminator (standard configuration): if without E-Stopper. Plug the E-stop terminator to the E-STOP IN port to enable the uFlamer II.

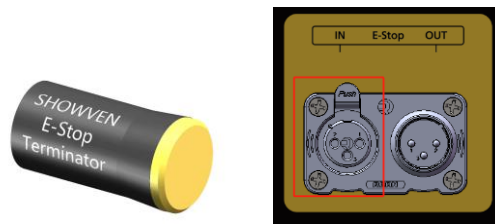

6. Connecting uFlamer II

Make sure the DMX or pyro controller is disarmed or powered off during cable connection.

If control by DMX controller, follow below steps:

- Connect a DMX cable to the DMX IN socket of first unit of uFlamer II, another head of this DMX cable connect to DMX console (such as FXcommander). Make sure the DMX console is powered off.
- Connect a DMX cable to the DMX OUT socket of previous uFlamer II, and the other end to the DMX IN of next machine. Connect all devices in series in this way.
- Suggest to plug in a DMX terminator into the DMX OUT in last unit of machine to improve signal reliability. For distance >200m please use SHOWVEN DMX splitter 8 to amplify the signal.
- Connect a power cable to the POWER IN socket of uFlamer II. Make sure power supply is consistent with the rated voltage of the equipment, and the socket must well grounded.
- Power on all uFlamer II. Check the safety lock, double confirm it stays at "TEST MODE".



- Assign DMX address for each unit of uFlamer II. If use SHOWVEN host controller or FXcommander to control the machine please allocate a unique DMX address for each unit of machine.

If control by 9-60V pyro signal, follow below steps:

- Connect a power cable to the POWER IN socket of uFlamer II. Connect the other end of power cable to the power source. Make sure power supply is consistent with the rated voltage of the equipment, and the socket must well grounded.
- Connect the power control cables to the 9-60V pyro signal connector on uFlamer II.
- Connect the other end of power control cables to the pyro controller (9-60V external trigger source), such as SHOWVEN PyroSlave series module. Before connect please make sure there is no pyro signal input.
- Power on all uFlamer II
- Set the Ext Ignite to ON status in advanced interface, set the firing duration.

7. Power ON the DMX console / Pyro controller and programming

Power on DMX console and program the uFlamer II effect on DMX console or Pyro controller.

8. Test the ignition function of uFlamer II

Test the ignition function of uFlamer II, we can check whether the igniters of each unit of uFlamer II is working fine. Due to the safety switch is stay at TEST MODE there will be only ignition while jet solenoid valve is not open, so no flames generated.

9. Firing

- Double confirm the prescribed safety isolation zone is clear, no person, animal or other property within this region.
- Switch the safety lock of uFlamer II to USER MODE.



- Firing, the operator should always have a clear view of the device, so that he/she can stop the show immediately when there is danger.

10. Depressurize and Power OFF



- Depressurize the flame unit after show or not use flamer for a period of time
- Power OFF DMX console
- Press E-Stopper to power OFF all machine (if connect with E-stopper)
- Switch safety lock of uFlamer II to TEST MODE
- Power OFF each unit of machine

11. Empty the remaining fuels and package machine

- Unplug power cable, DMX cable, E-Stopper connection cable etc.
- Suggest to empty the remaining fuels inside fuel tank before shipment and storage
- Package the machine after it is cool down

▲ Nozzle Replacement and Igniter Position Adjustment

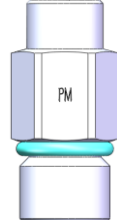
1. Nozzle Types and Flame Height

Nozzle Type	Picture	Short Flamer Height (m)	Long Flame Height (m)
Nozzle H SFSMA026		7-9m	10-12m
Nozzle PM SFSMA028		5-7m	8-10m
Nozzle L SFSMA024		3-5m	6-8m
Nozzle EL SFSMA027		3-4m	4-6m

2. Nozzle Replacement

Use 14mm outer hexagon socket wrench (SFMET944) to disassemble the nozzle, clean the nozzle and nozzle socket with air gun (air compressor), change a new nozzle and install it.



3. Igniter Position Adjustment

Whenever changed the nozzle or ignition is not good, please check igniter pole position according to below parameters. The right position for each pair of pole should have a gap from tip to tip of 2.5~3mm (b) and a gap between two igniter of 18mm (a). Check the ignition success rate after adjustment by firing

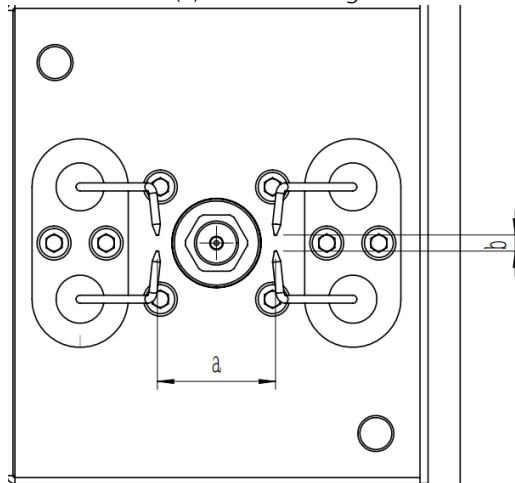

WARNING: Do unplug the power cable and power off the machine when service flamer.

4. Nozzle Installation

Please assemble the stainless steel gasket(RMSMA530), O ring and nozzle main part according to below picture. The O ring should be inside the stainless steel gasket, otherwise it may leads to fuel leakage.

Use nozzle replacement tool outer hexagon socket wrench to tighten the nozzle.

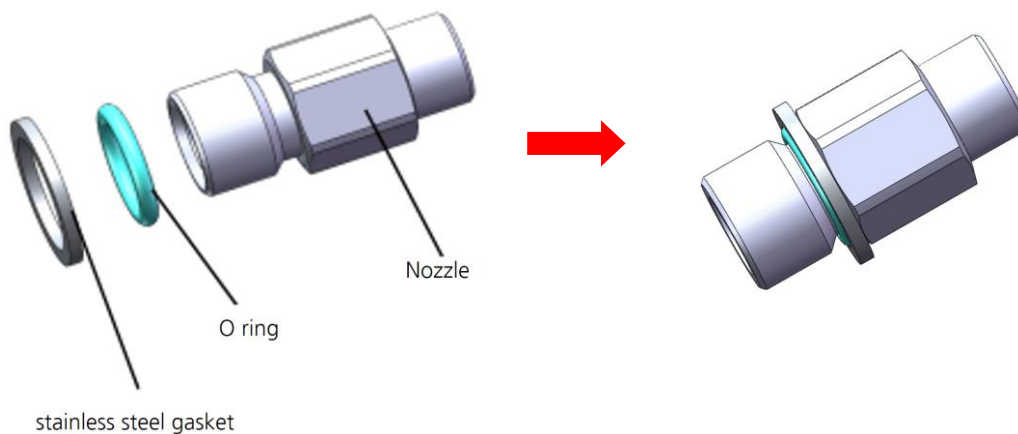

▲ Maintenance

1. To maintain the machine in good performance and running status, it is recommended to running the device at least once per month.
2. Check the ignition probes both before and after each show, if there is any foreign objects on it please clean it up.
3. Maintenance of the nozzle: Nozzle needs to be cleaned from time to time, and it is recommended that once every six months (depending on the environment and frequency of use). In the process of using the equipment, if the flame shape is seriously deformed or the fuel injection line is significantly deformed or coarsened, the nozzle should be removed immediately for cleaning. If after clean, there are still problems please replace new nozzle.
4. Maintenance of the O-ring: If it is found that the O-ring of the nozzle is damaged or ageing when cleaning the nozzle, the Fluorine rubber O-ring should be replaced in time. O ring outer diameter is 14mm, wire diameter is 2mm.
5. Flame detector maintenance: Recommended to clean the carbon buildup on flame detector at least once per month (depending on the use environment and frequency), if the detector is found to be insensitive, clean it immediately.
6. Emptying operation of the fuel tank

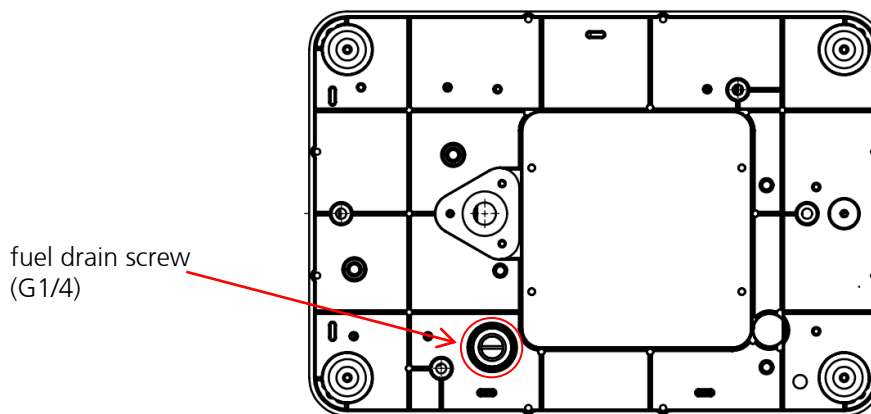

WARNING:

Please pay attention to the tightening torque of the fuel drain screw. It should not exceed **10N*m**, otherwise, the fuel tank will be damaged. This operation is prohibited for non-professionals.

▲ Optional Parts for uFlamer II

Part. No.	Description
SFSMA026	NOZZLE H
SFSMA028	NOZZLE PM
SFSMA024	NOZZLE L
SFSMA027	NOZZLE EL
RMSMA530	SS304 gasket, outer ϕ 18, inner ϕ 14, thickness 1.5mm
RMWAS025	Fluorine O ring, outer ϕ 14, wire diameter is 2 mm
SFMET1107	G1-E-Stop connector
FPEST001	E-STOPPER
RMMET516	G1-Anti-static battery disassembly spudger
RMPCK291	Paper carton
FPFLI056	2 in 1 Flightcase
SFMET944	Tool for exchange nozzle
RMBOT036	Safety loop
SFMET944	Nozzle disassemble tool
RMEMD062	5-pin wireless DMX receiver (compatible with FXcommander 2.4GHz wireless DMX)

Warranty Instructions

- √ Sincere thanks for your choosing our products, you will receive quality service from us
- √ The product warranty period is one year. If there are any quality problems within 7 days after shipping out from our factory, we can exchange a brand new same model machine for you
- √ We will offer free of charge maintenance service for machines which with hardware malfunction (except for the instrument damage caused by human factors) in warranty period. Please don't repair machine without factory permission

Below situations NOT included in warranty service:

- √ Damage caused by use unqualified fuels;
- √ Damage caused by improper transportation, usage, management, and maintenance, or damage caused by human factors;
- √ Disassemble, modify or repair products without permission;
- √ Damage caused by external reasons (lightning strike, power supply etc.)
- √ Damage caused by improper installation or use;

For product damage not included in warranty range, we can provide paid service.

Invoice is necessary when applying for maintenance service from SHOWVEN

SHOWVEN[®]



Showven Technologies Co., Ltd.

Tel: +86-731-83833068

Web: www.showven.cn E-mail: info@showven.cn

Add: No.1 Tengda Road, Liuyang Economic & Technical Development Zone, Changsha, Hunan, 410300,
P.R.China